

EST02 Product Specification

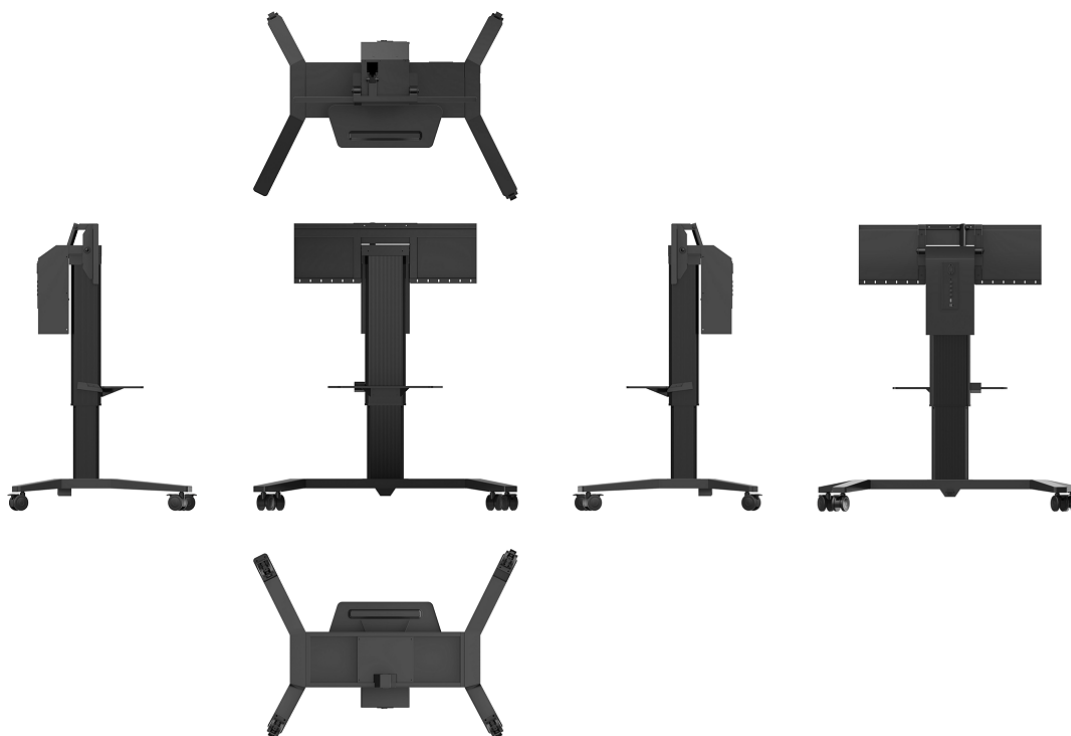

Dimensions:

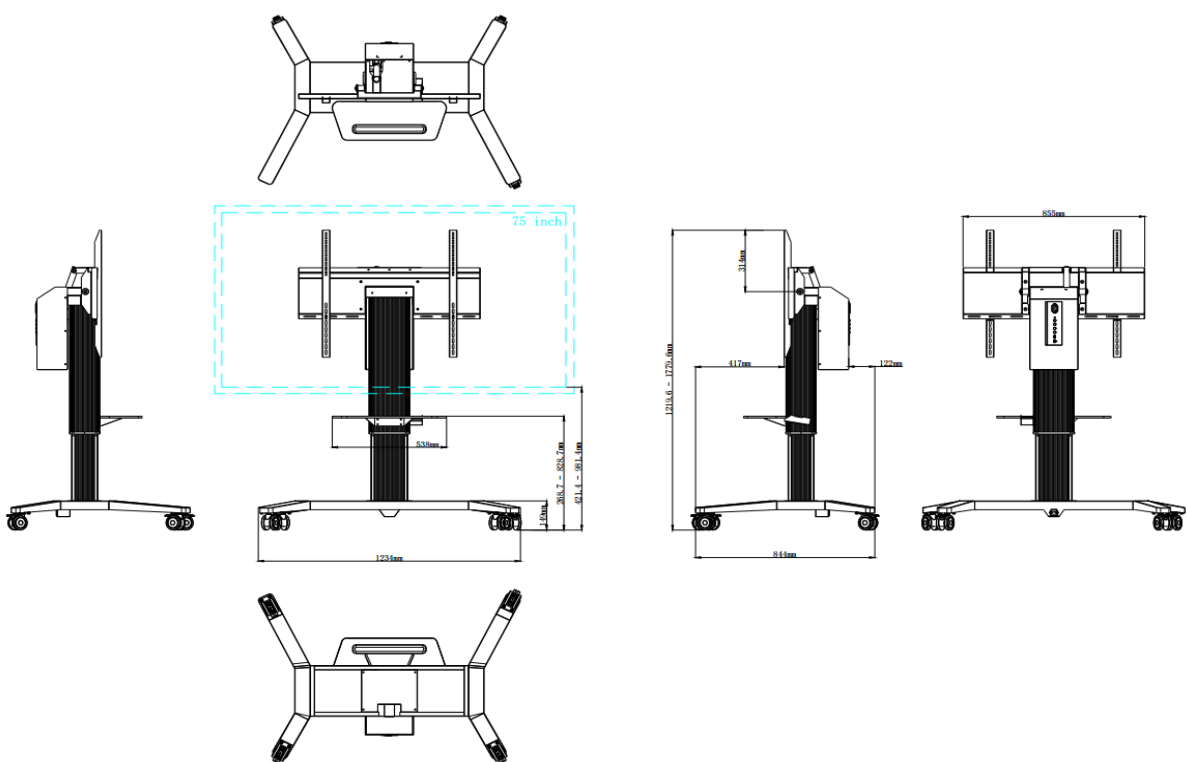

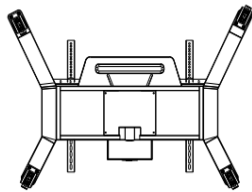
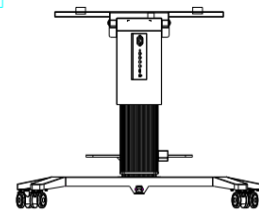
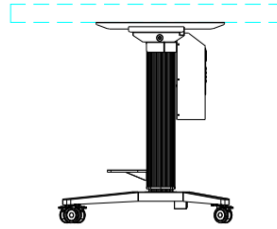
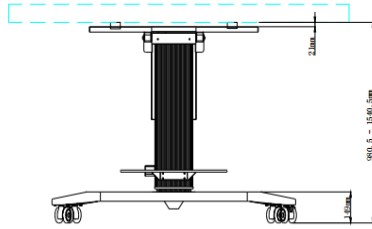
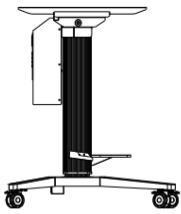
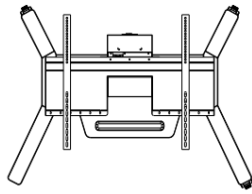

Product Specifications:

Physical Specifications

Dimension of the assembled Hanging plate (vertical) (L*W*H)	1234*844*(1219.6~1779.6) mm
Dimension of the assembled Hanging plate (Horizontal) (L*W*H)	1234*844*(980.5~1540.5) mm
Power Requirements	100~220V
Lifting Distance	560 mm
Flip Angle	90° (±1°)
Dimension with Package (L*W*H)	1342*934*372mm
Net Weight	52kg
Gross Weight	62kg
Largest Bearing	100kg
Max Load Size	Recommend No more than 75 inches
Control Mode	Control Panel /Control Pad/ Software
Truckle	Size
	3 inches

	Type(Non-mute/mute)	mute
Wall hanging	Standard	Support
	Compatible	9060A/9060F

Accessories

AC Power Cable	1
Remote Control	1
Quick Start Guide	1
Installation Manual	1
USB Adapter Cable	1
Screw Accessory Package	1
AC Power Adapter Cable	1

Environmental Conditions

Operation Temperature	0°C - 40°C
Operation Humidity	10% - 90%
Storage Temperature	-20°C -60°C
Storage Humidity	10% - 90%
Altitude	Below 5000 meters